

UM976446B

diaper 
genie[®]
 P L A T I N U M

Nappy bin
 Poubelle à couches
 Windeleimer
 Luieremmer
 Κάδος πάνας
 Autiņbiksīšu tvertne
 Sauskėnių dėžutė
 Cubo de pañales
 Kosz na pieluchy
 Blöjhink
 Koš na pleny
 Caixa para fraldas
 Blespand
 Kôš na plienky
 Contenitore per pannolini
 Hasznáلتpelenka-tároló
 Coş de gunoi pentru scutece
 Koş za plenice
 Kanta za pelene
 Mähkmete prügikast
 контейнер для подгузников



EN - Keep instructions for future reference.
FR - Conservez les instructions pour référence future.
GE - Bewahren Sie die Anweisungen für zukünftige Referenz auf.
DU - Bewaar de instructies voor toekomstige referentie.
SP - Conserve las instrucciones para referencia futura.
PT - Guarde as instruções para referência futura.
IT - Conserva le istruzioni per riferimento futuro.
EL - Κρατήστε τις οδηγίες για μελλοντική αναφορά.
PL - Zachowaj instrukcje do przyszłego wykorzystania.
HU - Őrizze meg az utasításokat későbbi hivatkozásra.
RO - Păstrați instrucțiunile pentru referințe viitoare.
SV - Spara instruktionerna för framtida referens.
DA - Opbevar instruktionerne til fremtidig reference.
SL - Shranite navodila za prihodnjo uporabo.
SK - Uchovávajte pokyny pre budúcu referenciu.
CS - Uchovejte pokyny pro budoucí použití.
HR - Čuvajte uputstva za buduću upotrebu.
LT - Išsaugokite instrukcijas būsimiems nuorodoms.
LV - Saglabājiet norādījumus turpmākai atsaucei.
ES - Hoidke juhised tulevikuks kasutamiseks.
RU - Храните инструкции для будущего использования.

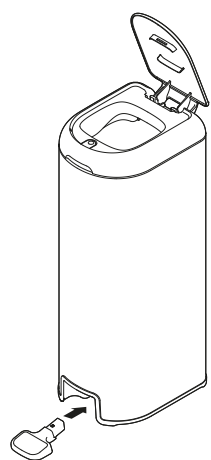
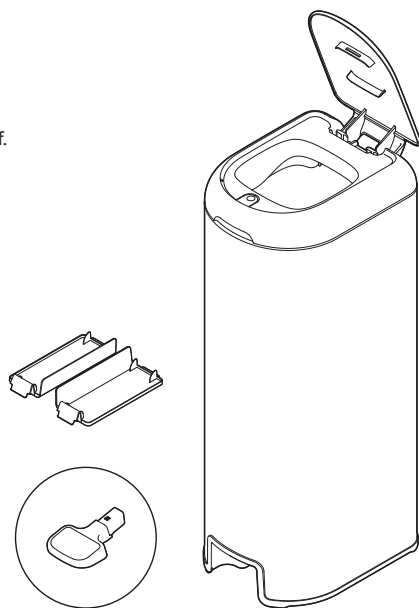

1

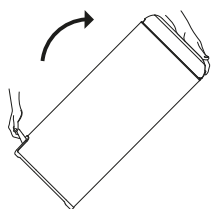

2

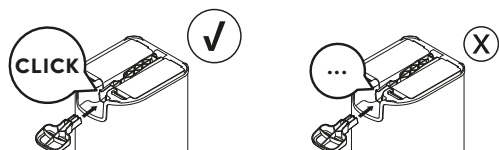

1

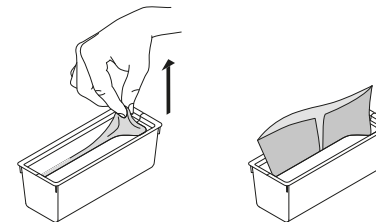

2

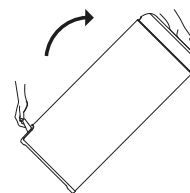

3

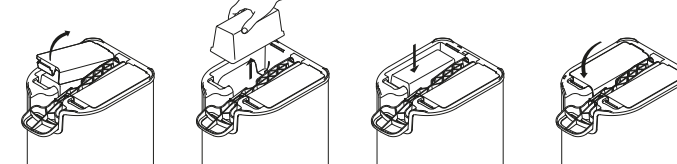

4

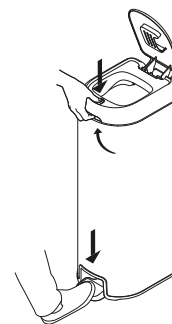

5

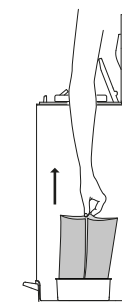

6

